

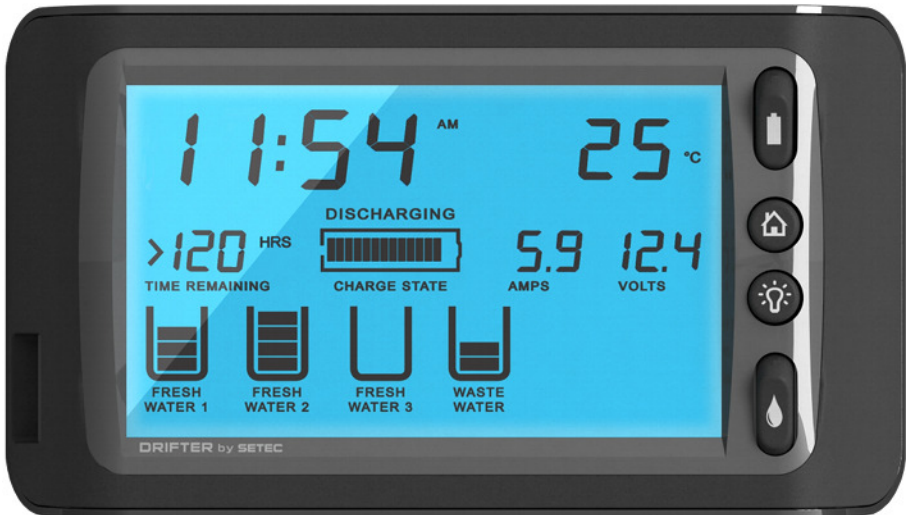

DRIFTER

Owner's Manual



Please read the Installation section of this manual before installing the product.

Copyright © Setec Pty Ltd 2013

Disclaimer

Setec Pty Ltd makes no claim as to the accuracy or suitability of the information contained in this manual. Setec Pty Ltd accepts no liability for any loss or damage, which may occur as a result of improper or unsafe use of its products.

Warranty is only valid if the unit has not been modified by the customer and has not been misused.

Contents

Introduction.....	4
Safety Precautions.....	4
Accessories.....	5
Other Required Items.....	5
About the Drifter.....	6
Names and Functions of Parts.....	7
Operation.....	8
Description of Display Elements.....	8
Description of Switches and Buttons.....	9
USB Charger	10
Clock Setting.....	11
Advanced Configuration.....	11
Enabling Parameter Set-up Mode.....	11
New Battery Installation.....	13
Accelerated Capacity Learning.....	13
Connectors.....	14
Installing The DRIFTER.....	15
Personnel.....	15
Installation Environment.....	15
Mounting.....	15
Battery Shunt Wiring.....	19
Water Tank Level Wiring.....	21
Servicing.....	28
Specifications.....	28
After-sales Service.....	28
Repairs and After-sales Service.....	28
Warranty Terms and Conditions.....	30

Introduction

Safety Precautions

Please read the Safety Precautions carefully before installing the power supply. Be sure to observe all precautions without fail.

After completing installation, conduct a trial operation to check for faults.



WARNING

Failure to follow these instructions properly may result in personal injury or loss of life.

This appliance is not intended for use by young children or infirm persons without supervision. Young children should be supervised to ensure that they do not play with the appliance.



CAUTION

Failure to observe these instructions properly may result in property damage or personal injury, which may be serious depending on the circumstances.

Refer to the installation section before operating. Correct installation is the most critical factor in ensuring the safe use of the power supply. If every consideration of these instructions has been satisfied the power supply will be safe to operate.

Ensure that cable connections have the correct polarity and are protected against accidental short circuit.

Do not allow water or other liquids to enter the installation area.

Accessories

The following accessories are provided with the retail pack for this product.



Owner's Manual

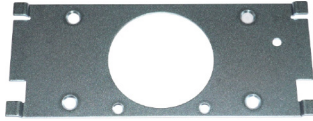

021386 Mounting bracket



019508 Battery Neg cable



019230 Current shunt



021352 Single-bung water level sensor (Qty 2)

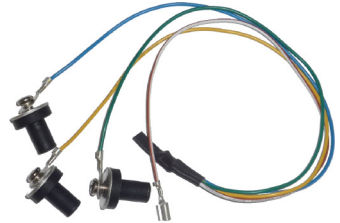

021350 Three-bung water level sensor (Qty 2)



022924 Battery shunt cable, 9m



022923 Remote shutdown cable, 9m

Other Required Items

- Two-core cable for connecting between the Drifter and the water tanks
- QC terminals or similar for the above cable

Refer to the installation section of this manual for details.

About the Drifter

Designed specifically for caravan applications, the Drifter is a display unit that monitors water tank levels and the 12 V battery charge state. Its backlit LCD presents information such as:

- Battery voltage
- Current flowing in (charging)
- Current flowing out (discharging)
- Estimated battery charge status and the estimated time to discharge
- Level indication of up to 4 water tanks including 1 waste water indicator
- Time (digital clock) with am/pm
- Ambient temperature
- Water pump status
- Battery on/off status

Features also include:

- Back light which can be set as a night light
- USB charger
- Water pump (on/off switch)
- Battery (on/off switch)

Names and Functions of Parts

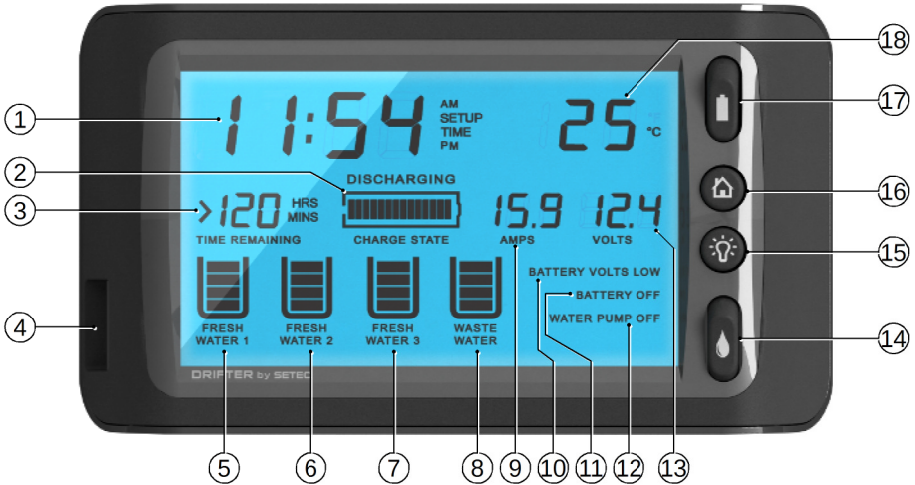

- ① **Clock display**
Current time in 12 hour mode
- ② **Battery charge state**
- ③ **Battery time remaining**
while discharging at current discharge rate.
- ④ **USB charger**
Generic 1 Amp USB charger
- ⑤ **Water level in tank 1**
- ⑥ **Water level in tank 2 (if fitted)**
- ⑦ **Water level in tank 3 (if fitted)**
- ⑧ **Level in waste water tank**
- ⑨ **Battery current**
- ⑩ **Warning Annunciator**
Displays if battery voltage is low
- ⑪ **Switch status annunciator**
Displays if battery is isolated by switch ⑰
- ⑫ **Switch status annunciator**
Displays if water pump is switch off by switch ⑭
- ⑬ **Battery voltage**
- ⑭ **Water pump switch**
- ⑮ **Backlight switch**
- ⑯ **Displays the home screen**
Setup functions change the meaning of some fields; this button restores the display to normal functions.
- ⑰ **Battery isolate switch**
When paired with a compatible power supply, this switch will isolate the battery from the loads.
- ⑱ **Ambient temperature**
Ambient temperature in °C

Operation

In normal power-on mode the unit displays the Home screen. The various display elements of the Home screen are described below.

Description of Display Elements

Clock ①

This displays the time of day in 12-hour mode with AM/PM indication. To set the clock, refer to Clock Setting on page 11.

Temperature ⑱

This displays the ambient or room temperature. The temperature sensor is located in the bottom left corner of the unit. The temperature can only be displayed in Celsius.

Time Remaining ③

This is the time remaining in the battery if it continues to discharge at the current rate.

- If the remaining time is 2 hours or less, the display shows the remaining time in minutes.
- If the remaining time is greater than 2 hours, the display shows the remaining time in hours.
- If the remaining time is greater than 199 hours, the display shows “>199 HRS”.
- If the battery is charging, the display is blank.

Charge State ②

This is a multi-segmented bar graph showing the state of charge of the battery. Above the bar graph is displayed the word “CHARGING” or “DISCHARGING” according to charging state of the battery.

Amps ⑨

This shows the charging current into the battery or the discharging current from the battery. To determine if it is a charging or discharging current it is necessary to refer to the Charge State indicator to the left of this field.

Volts ⑬

This displays the battery voltage.

Fresh Water Tanks ⑤ ⑥ ⑦

These indicate the approximate water level in each of the tanks.

If a tank is not installed that tank indicator will always show empty (no level segments will be shown).

When full, all level segments are shown.

When empty, the bottom level segment flashes and the other segment are not shown.

Note: If the pump switch is off, the water level displays are not updated; they continue to show the levels from the last time the pump switch was on.

Waste Water Tank ⑧

This indicates the approximate level in the waste water tank.

If the tank is not installed the indicator will always show empty (no level segments will be shown).

When full, all level segments are shown and are flashing.

When empty, only the bottom level segment is shown.

Note: If the pump switch is off, the display is not updated; it continues to show the level from the last time the pump switch was on.

Battery Volts Low ⑩

This indicator shows when the battery voltage is at or below 11.0 Volts.

Battery Off ⑪

This indicator is displayed when switch ⑰ is in the up position.

Water Pump Off ⑫

This indicator is displayed when the water pump switch ⑱ is in the off position.

Description of Switches and Buttons

Battery Switch ⑰

Note: This Drifter product is designed to interface with the Setec ST-III series power supplies. The functionality described below assumes the Drifter has been correctly connected such a power supply.

The Battery Switch is used to disconnect the battery from the loads.

In the up position the battery cannot power the loads and "BATTERY OFF" ⑪ is

displayed. In this condition (provided mains power is connected) the power supply powers the loads and trickle-charges (slow charges) the battery.

In the down position no battery annunciator is shown and the battery will power the loads if no mains power is connected. Provided mains power is connected, the power supply keeps the battery charged.

Note: This switch also enables/disables the **USB charging port** (even if the Drifter is not being used with an ST-III series power supply).

Home Button ⑬

The Home button is used

- in entering setup modes
- in changing settings
- to turn on the back-light

It has no other functions.

Its usage is described in the relevant sections.

Back-light Button ⑮

The Back-light button is primarily used to enable display back-lighting. It is also used in entering setup modes and in changing settings.

Back-light Functionality

Turn on back-light temporarily: Press either the **Home** or **Back-light** buttons. The back-light will automatically turn off after 30 seconds.

Turn on Back-light Permanently: With the back-light off, press and hold the **Back-light** button until the back-light blinks (approximately three seconds).

Turn off back-light: Press the **Back-light** button. This cancels both temporary and permanent back-light display.

Water Pump Switch ⑭

This switch controls power to the water pump.

In the up position the pump is off and the display shows "WATER PUMP OFF" ⑫.

In the down position the pump is powered and the display does not show any water pump annunciator.

USB Charger ④

A standard USB-style charger is integrated into the DRIFTER.

Charge current is limited to 0.9 A.

Clock Setting

1. Ensure the display is in normal mode (not in any setting mode).
2. Press and hold the **Home** button for at least 5 seconds. The minutes digits will start flashing, the “TIME” annunciator will be displayed, and all other non-relevant display segments are turned off.
3. Pressing the **Home** button will now toggle between setting the hours digits and minutes digits.
4. To increment the flashing digits, press the **Back-light** button.
 - Incrementing the minutes digits past 59 does not increment the hours digits.
5. To exit the Clock Setting mode, do not press any button for at least 15 seconds. When the display returns to its normal appearance, it means setup mode has been exited.

Advanced Configuration

These parameters are factory set.

Unless you are changing batteries or changing the number of water tanks, there is no need to enter this mode.

Enabling Parameter Set-up Mode

1. Ensure the display is in normal mode (not in any setting mode).
2. Press and hold the **Home** and **Back-light** buttons for at least 5 seconds.

When Parameter Set-up Mode is entered:

- The “SETUP” annunciator is on (near the AM/PM indicators)
 - The temperature digits show the parameter number
 - The clock digits show the parameter value
 - All other LCD segments are off.
3. Pressing the **Home** button displays the next parameter and its value. If the last parameter is displayed, pressing the **Home** button displays the first parameter. The available parameters are shown in Table 1: Setup Parameters below.
 4. To increment the parameter value, press the **Back-light** button.
 - Incrementing past the maximum value causes the lowest value to be

selected.

- For some parameters holding pressed the **Back-light** button will force a fast or slow increment of its value.
5. To exit the Parameter Setting mode, do not press any button for at least 15 seconds. When the display returns to its normal appearance, it means setup mode has been exited.

Parameter Number	Description	Default Value	Range
1	Enables water tank sensor 1	1	0 – 1
2	Enables water tank sensor 2	0	0 – 1
3	Enables water tank sensor 3	0	0 – 1
4	Enables waste water tank sensor	1	0 – 1
5	Battery capacity—the rated capacity of the battery Amp-hours	100	7 – 999
6	Battery operating temperature in °C	25	-20 – +50

Table 1: Setup Parameters

Tank Sensors

If a tank sensor is enabled but no tank sensor is connected, the tank level will be shown as either full or empty, depending on whether the pump switch is on or off. By disabling the sensor the tank level is always shown empty.

Battery Capacity

This is the actual capacity of the battery in Amp-hours.

When a new battery is fitted, set this to the nominal battery capacity (as marked on the battery); doing this will assist the software in determining the actual capacity.

As the DRIFTER learns the battery capacity, it will automatically update this parameter.

Battery Operating Temperature

This is the typical operating temperature of the battery in degrees Celsius. This helps improve the accuracy of the predicted time-remaining readout ③.

New Battery Installation

The DRIFTER unit is a smart battery monitor in that it is able to learn the actual battery capacity and thus provide more accurate “Time Remaining” feedback to the user. When an existing battery is replaced by a new one, the capacity of the new one is likely to be much higher.

Fitting a new battery and doing nothing else will result in the “Time remaining” display initially being quite inaccurate. As the battery is charged and discharged during normal use, the DRIFTER unit will learn the battery capacity of the new battery.

Accelerated Capacity Learning

This procedure should only be used when an existing battery has been replaced with a new battery.

The general method the DRIFTER uses to quickly learn the battery capacity is to measure the Amp-hours required to flatten a fully charged battery. (“Quickly” is a relative term; we suggest you allow one to two days for this process.)

The detailed process we recommend is as follows:

1. Enter the Setup Mode and view the Battery Capacity parameter. It should be set to the manufacturer's rated capacity for that battery. e.g. 80 Ah
2. Charge the battery until the State of Charge reads 100%. This indicates the battery is fully charged.
3. Stop charging the battery. i.e. remove the 240V power.
4. Switch on loads (e.g. lights, TV etc.) until the battery is being discharged at 10% – 20% capacity rate.

e.g. If you have an 80 Ah battery, 10% of 80 is 8, 20% of 80 is 16.
So, adjust the loads until the battery current  reads between 8A and 16A.

Note: When discharged at the 20% rate, the discharge time will be approximately 5 hours. At the 10% rate, the discharge time will be approximately 10 hours.

5. Wait until the battery has gone flat.
If you are using the DRIFTER with a Genius-series power supply or a SETEC ST-series power supply, this will not damage the battery. Those power supplies have a low voltage disconnect which protects the battery from discharging to a damaging level. With these products the flat battery state will be indicated by the battery current dropping to zero and there being no power to lights etc.

If using with a power supply without a low voltage cutout, you must monitor the battery voltage  and, when it reaches 10.5 V, turn off the loads.

When the loads are turned off, or when the low-voltage disconnect has been activated, the battery voltage will increase slightly—this is normal.

6. View the Battery Capacity parameter—it will have been updated to a new value. This new value is likely to be different to what was initially entered, but it is a better estimate of the actual battery capacity.
7. Repeat steps 2 to 5 once or twice more.
8. The capacity-learning process is now complete.

Connectors

At the rear of the DRIFTER are two connectors. The connector type and pin functions are defined in Tables 2 and 3 below.

Connector: Phoenix Contact MCV1.5/5-G-3.5 or equivalent		
Pin	Signal	Description
1	+Vs	Battery-voltage positive sense line
2	+Ve PWR	+12V connection to power the DRIFTER
3	0V PWR	0V connection to power the DRIFTER
4	-Is	Battery-current sense resistor, negative connection
5	+Is	Battery-current sense resistor, positive connection

Table 2: 5-way Connector

Connector: Phoenix Contact MCV1.5/9-G-3.5 or equivalent		
Pin	Signal	Description
1	PUMP OUT	Positive connection of water pump
2	PUMP +12V	+12V supply for water pump
3	RB_B	Remote battery/load disconnect
4	RB_A	Remote battery/load disconnect
5	0V	Common 0V
6	T4	Tank-level sensor 4
7	T3	Tank-level sensor 3
8	T2	Tank-level sensor 2
9	T1	Tank-level sensor 1

Table 3: 9-way Connector

Note: The digit '1' is moulded into the rear of the Drifter case beside each connector, indicating the location of pin 1.

Installing The DRIFTER

Personnel

Installation is to be carried out only by suitably qualified personnel.

Installation Environment

The DRIFTER should be located indoors where it will not be subject to water or other liquid spills or splashes.

In addition, for the temperature display to be usefully accurate, the DRIFTER should be located where it will not be subject to hot or cold drafts. e.g. above a kettle is an undesirable location from both a moisture and temperature perspective.

Mounting

The DRIFTER is supplied with a mounting bracket for attaching to the wall.

- Mounting screws should be proud of the bracket by more than 1.8mm in order to allow the DRIFTER to fit on the bracket.
- The access hole to the wall cavity must be similarly sized to that in the bracket to provide clearance for the connectors at the back of the DRIFTER.
- See Figure 1 for details.

When wiring is completed and the connectors are mated to the unit, fit the DRIFTER as detailed in Figure 2.

If it is ever necessary to remove the DRIFTER from its mounting bracket, follow the instructions in Figure 3.

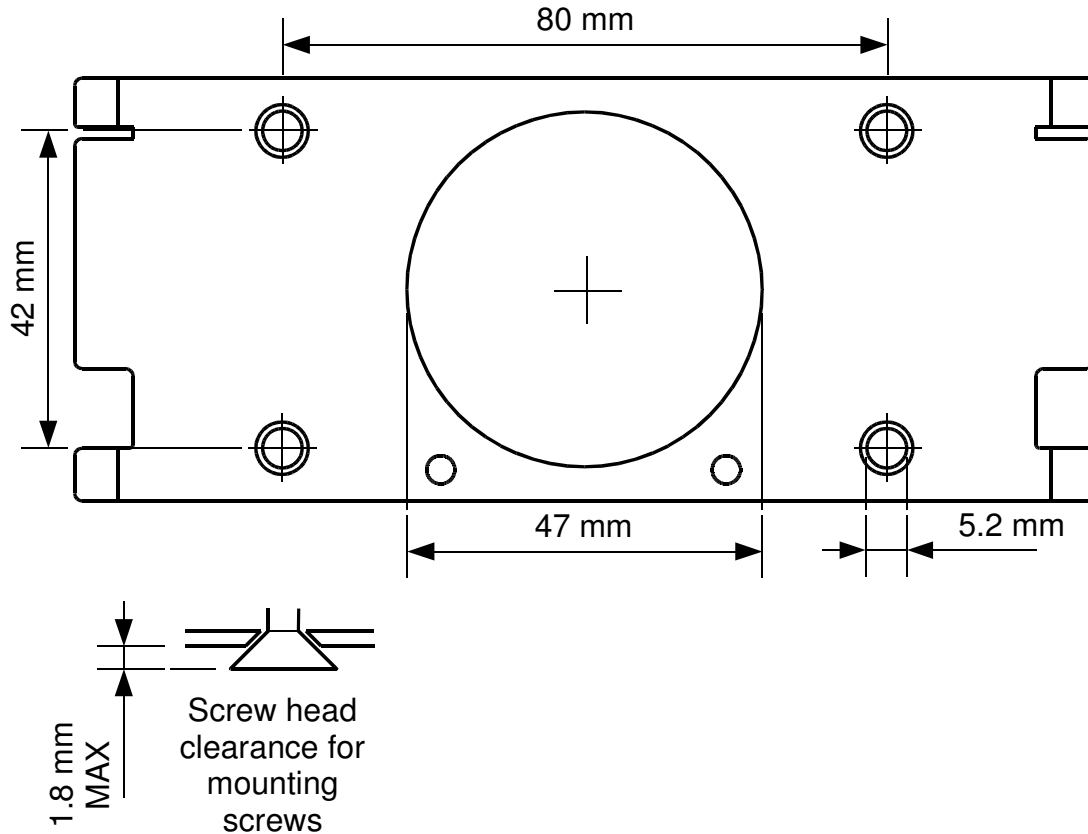
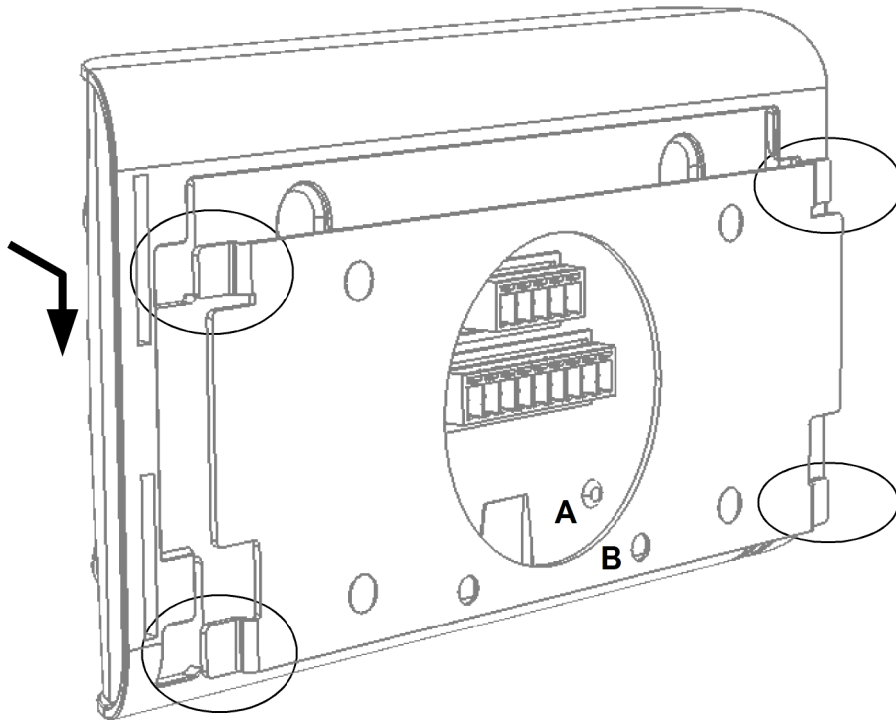
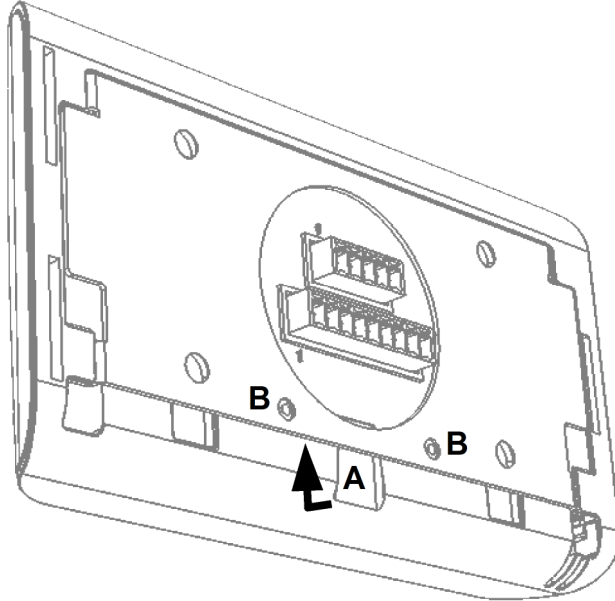

Figure 1: Mounting Bracket Details



Locate the DRIFTER over the four bracket tangs, then push down until dimple 'A' locks in hole 'B'.

Figure 2: Fitting DRIFTER onto mounting bracket



Insert flat-blade screwdriver into slot 'A'
Gently lever case away from bracket
enough for dimples 'B' to clear locating holes
Then slide DRIFTER upwards.

Note: Some force may be needed to slide
the DRIFTER upwards because it usually
binds tightly on the four locating tangs.

Figure 3: Removing DRIFTER from mounting bracket

Battery Shunt Wiring

Important: To keep track of the battery capacity, this product needs to be able to measure ALL current into and out of the battery.

This is achieved by connecting a current-sensing shunt between the battery negative terminal and all 0V connections. This connection arrangement is shown in Figure 4 below.

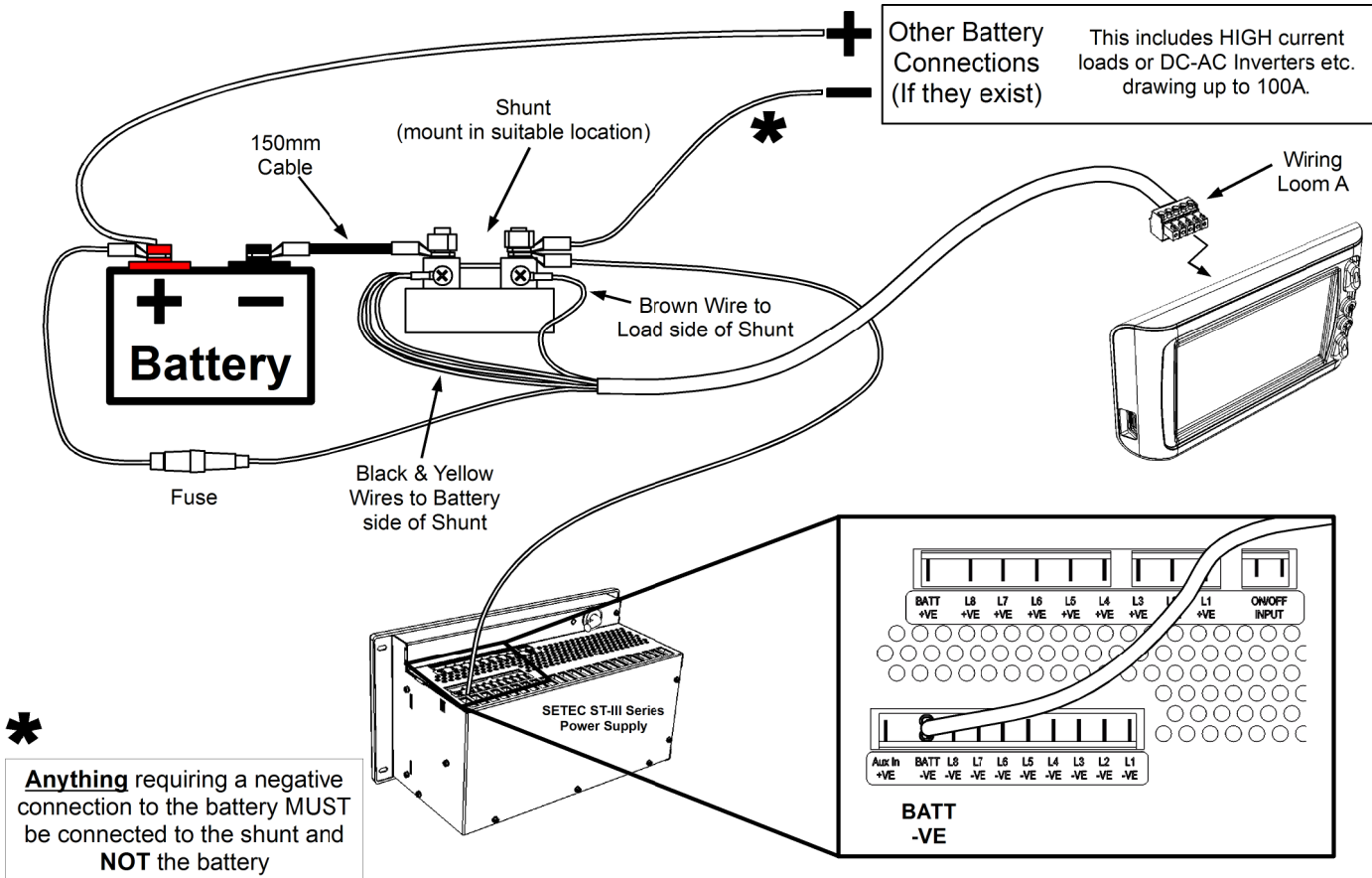

Figure 4: Battery Shunt Wiring

Water Tank Level Wiring

- (a) Empty the water from the tank(s)
- (b) Choose a suitable side of the tank where the level-sensing bungs can be located.
- (c) Drill the required holes as shown in Figure 5 below.
- (d) Fit the four bungs to the holes as detailed in Figure 6. Pay particular attention to which bung goes into which hole, matching the wire colours as shown in Figure 6.
- (e) Connect the pump and remote on/off switch as detailed in Figure 7 (assuming Setec ST-III series power supply is used). If used with other power supplies, connect according to Figure 8.
- (f) Connect the water-tank sensors as detailed in Figure 9.
- (g) Fill the tank(s) and check for water leaks around the bungs. Reseal as necessary.
- (h) Test operation of water level sensors, water pump switch, and remote on/off switch.

Drill Holes:

Ensure Water Tank is empty before proceeding.

Drill four (4) Ø10mm holes in Water Tank.

The bottom bung is to be located as close as practical to the bottom of the tank.

The Top bung is to be located at desired height for 'Tank Full' Indication, recommended height is $\frac{3}{4}$ full depth

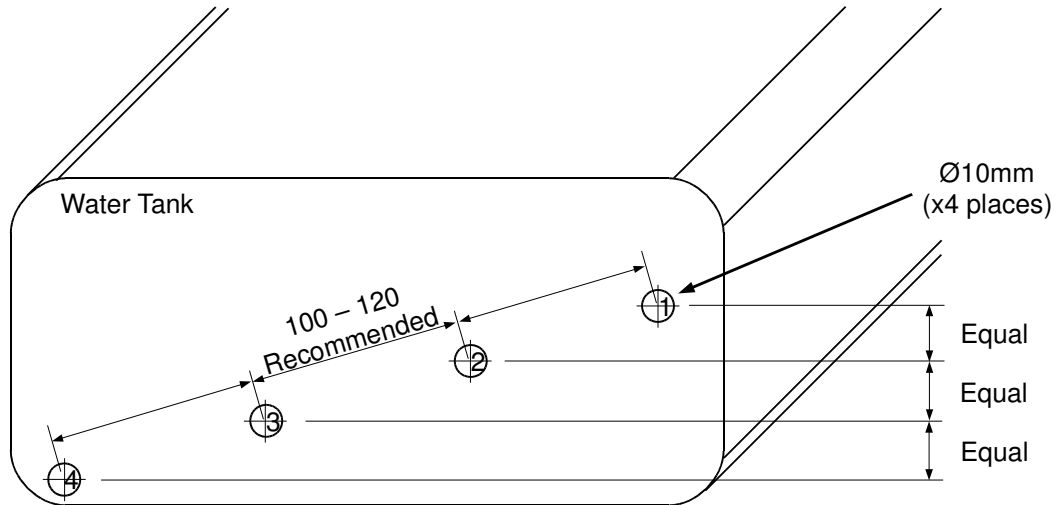

Figure 5: Tank Preparation

Insert Bungs:

Bungs **MUST** be assembled into the tank in the order shown otherwise the product will **NOT** function properly.

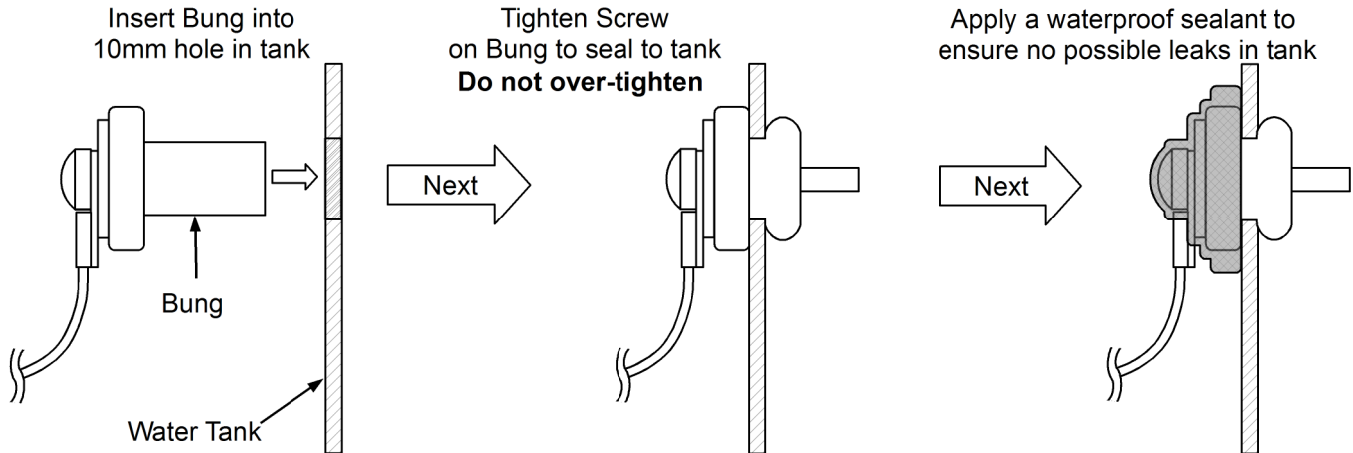
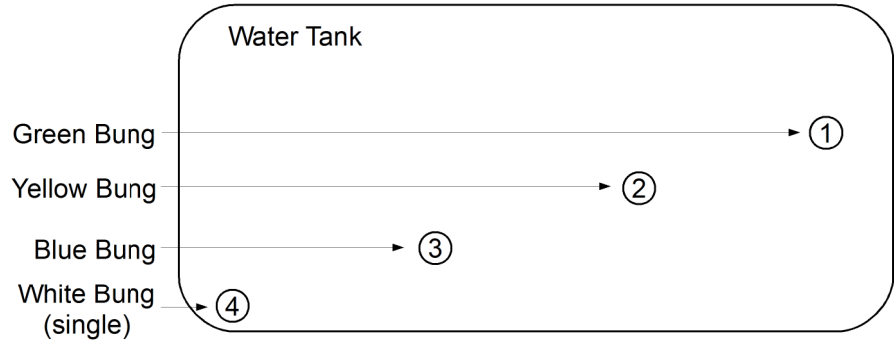

Figure 6: Fitting water-level bungs

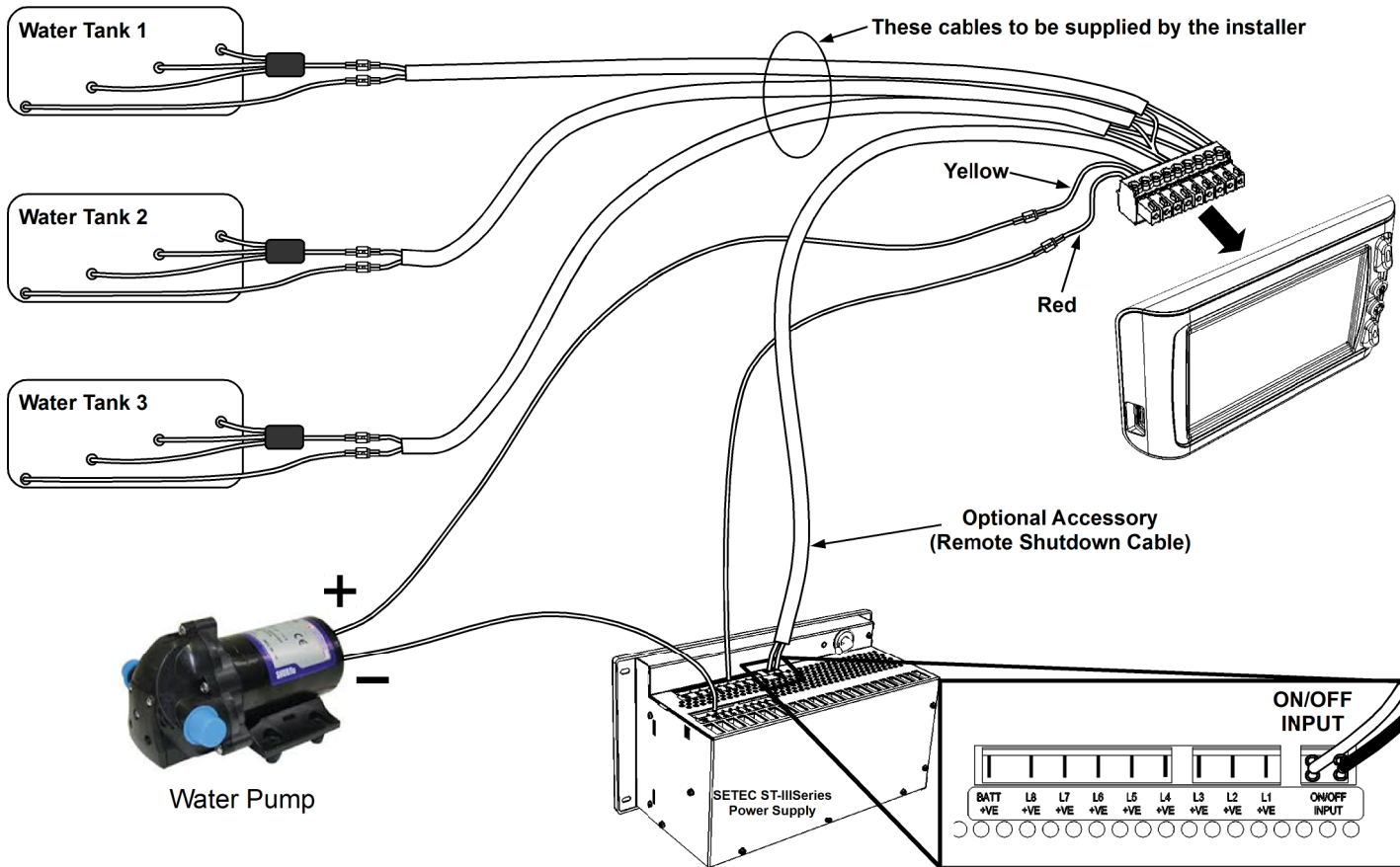

Figure 7: Tank, pump, and remote switch connection for ST-III Series Power Supplies

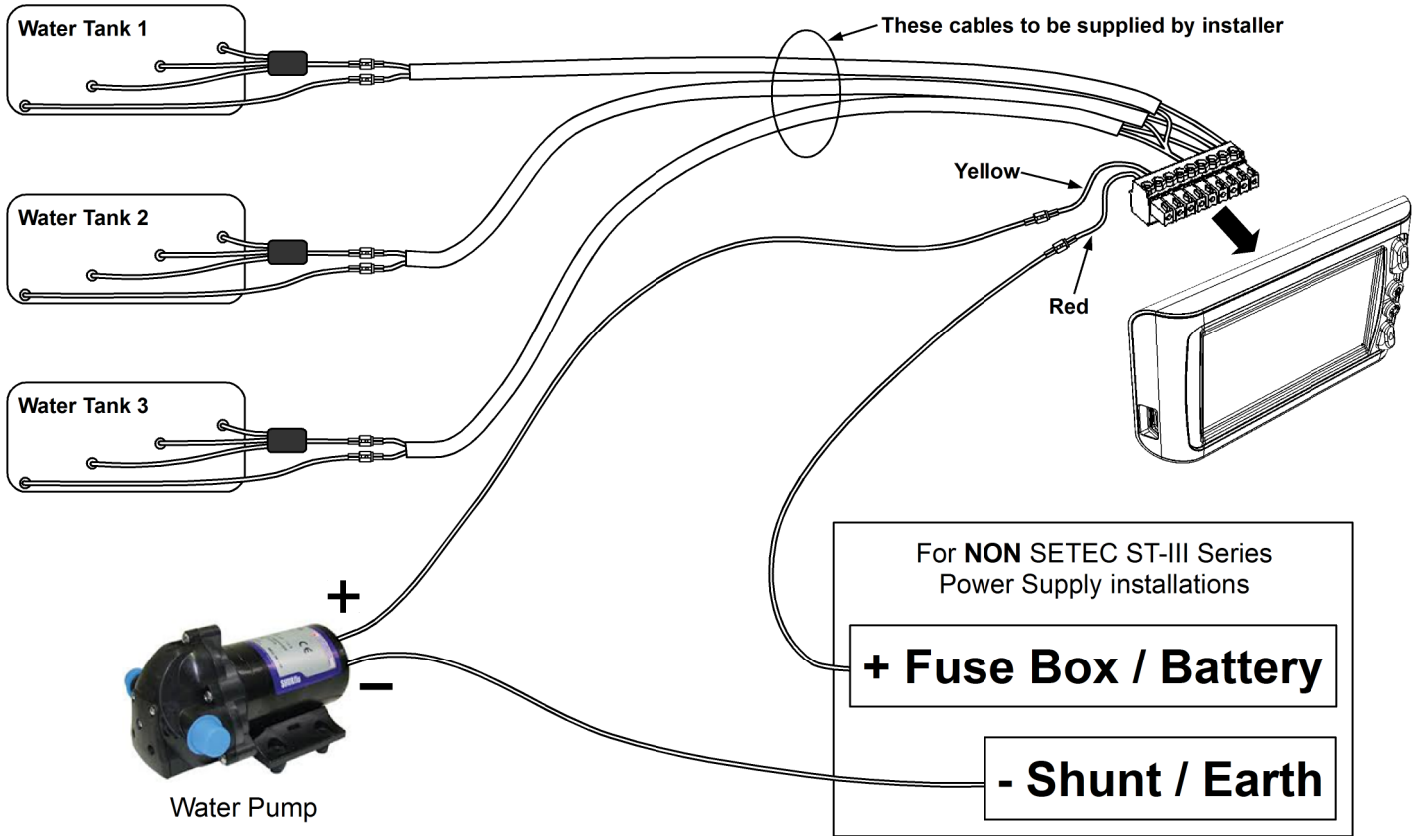
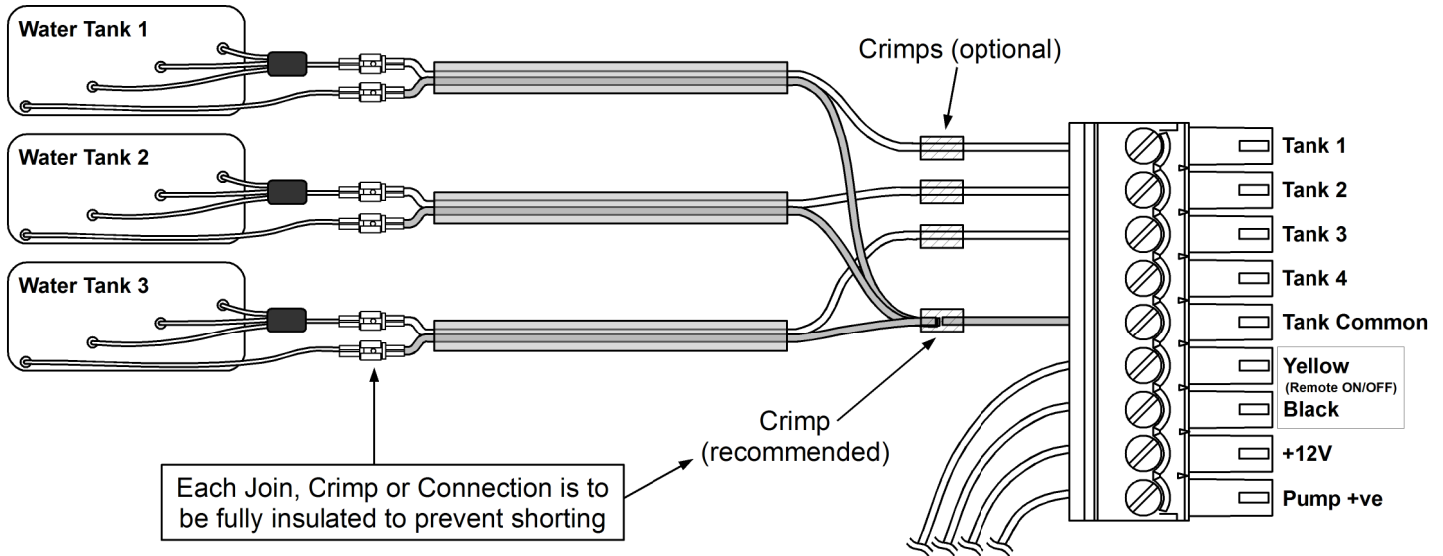

Figure 8: Tank and pump connection (for NON SETEC ST-III Power Supply based Installation)



Wiring:

When connecting tank bung wires to the connector, either crimp to wires supplied in connector or remove them and insert wires directly into the connector.

Tank Common:

It is recommended that a crimp is used to join all three (3) common tank wires as they may not fit if inserted directly into the connector.

Figure 9: Tank Sensor Wiring

Servicing

There are no internal user serviceable parts.

Specifications

Input Voltage:	8 – 15 Vdc
Battery Drain:	< 3 mA (backlight off, no USB-attached device)
USB Output:	0.9 A max, charger only
Ambient Temperature:	0 C – 50 C
Size:	149 Wide x 85 High x 22 Deep

After-sales Service

 WARNING: Do not disassemble, modify, or repair the unit.

Doing so may result in electric shocks or fire.

Repairs and After-sales Service

Consult your Setec dealer.

Notes:

Warranty Terms and Conditions

The benefits provided to you under this warranty are in addition to any other rights or remedies you may have, as a consumer, under any other law which applies to Setec Pty Ltd products. Setec Pty Ltd goods come with guaranties that cannot be excluded under the Australian Consumer Law. You are entitled to a replacement or refund for major failure and for compensation for any reasonably foreseeable loss or damage. You are entitled to have the goods repaired or replaced if the goods fail to be of acceptable quality and the failure does not amount to a major failure.

Under this warranty Setec Pty Ltd agrees to repair or replace, at our cost, the product purchased by you in Australia if the product does not perform in accordance with the manufacturer's specifications during the period of this warranty.

The DRIFTER warranty is valid for a period of one year from the original date of purchase. Please retain your proof of purchase, as this will need to be provided should you wish to claim under this warranty.

To be able to claim under this warranty you must

- (a) Ensure the product is installed by a suitably qualified person and is installed in accordance with this Owner's Manual and any applicable Australian Standard.
- (b) The product must be operated in accordance with the instructions detailed in this manual.
- (c) The product must be maintained in accordance with the instructions detailed in this manual.

What is excluded from this warranty? Cover for any damage, malfunction or failure resulting from incorrect installation, accidental damage, misuse, abuse, tampering, unauthorised repairs, unauthorised modification by any person, corrosive environment, or infestation by insects or vermin are excluded under this warranty and Setec Pty Ltd accept no liability for the same.

How to make a claim under this warranty.

- (a) Contact Setec Pty Ltd on 03 9213 8400, or your Setec dealer, to obtain return authorisation.
- (b) Package the product adequately to prevent any further damage, and send the product to location provided when you received your return authorisation.
- (c) Please include with the product, proof of purchase, a detailed description of the fault, and your contact details.

Setec Pty Ltd may seek reimbursement of any costs incurred by them if a product is found to be in good working order.



DESIGNED AND
MANUFACTURED IN
AUSTRALIA